



VN	VIETNAM
----	---------

Diagram / Parts List

GA7071

180MM ANGLE GRINDER



(VN) GA7071 / 180MM ANGLE GRINDER

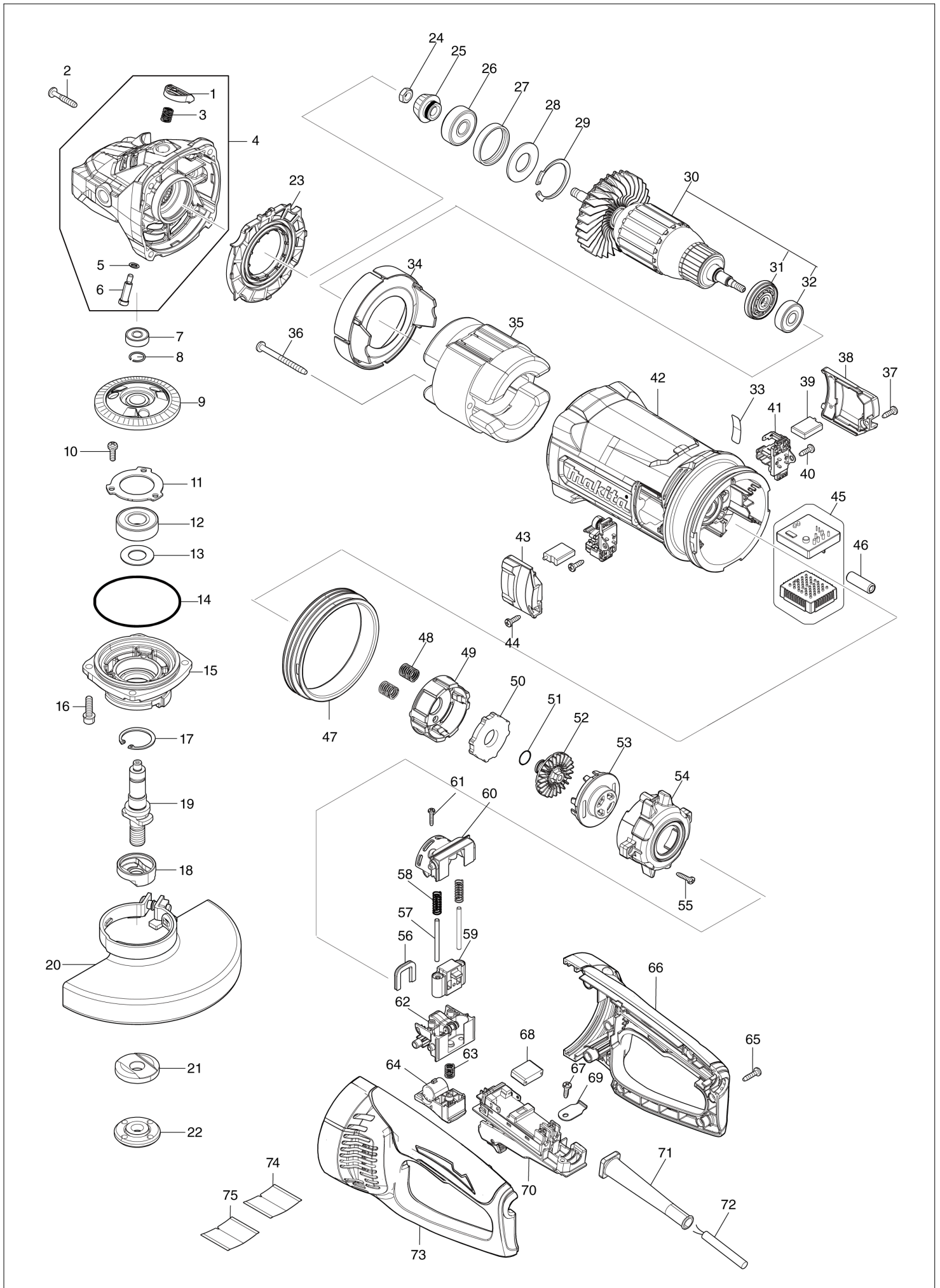

VN	VIETNAM
-----------	----------------

GA7071 / 180MM ANGLE GRINDER

Item	Sub	Parts No.	Parts Description	Qty	I/C	E/C No.	Close No.	Remark
001		456247-8	PIN CAP	1				
002		266553-1	TAPPING SCREW 5X30	4				
003		234391-9	COMPRESSION SPRING 8	1				
004		140Y89-7	GEAR HOUSING COMPLETE	1				
	C10	263002-9	RUBBER PIN 4	1				
	C20	262118-7	FELT RING 18	1				
	D10		INC. 1,3,5,6					
005		213026-5	O RING 7	1				
006		256571-7	SHOULDER PIN 7	1				
007		211032-4	BALL BEARING 608ZZ	1				
008		233925-5	RING SPRING 13	1				
009		227656-6	SPIRAL BEVEL GEAR 55	1				
010		265120-9	PAN HEAD SCREW M5X16	3				
011		285741-1	BEARING RETAINER 50	1				
012		211278-2	BALL BEARING 6203DDW	1				
013		267487-1	FLAT WASHER 17	1				
014		213760-7	O RING 78	1				
015		312A97-6	BEARING BOX	1				
016		265541-5	HEX. SOCKET HEAD BOLT M6X22	4				
017		962151-6	RETAINING RING R-32	1				
018		310800-3	LEAD FLANGE	1				
019		327762-8	SPINDLE	1				
020		122889-7	WHEEL COVER 180K ASSEMBLY	1				
	C10	213017-6	O RING 6	1				
	C20	265198-2	+PAN HEAD SCREW M8X25	1				
021		224447-6	INNER FLANGE 42B	1				
022		224485-8	LOCK NUT 14-45	1				
023		456238-9	DIFFUSER	1				
024		252194-9	HEX. NUT M8	1				
025		227655-8	SPIRAL BEVEL GEAR 17	1				
026		211132-0	BALL BEARING 6301DDW	1				
027		262085-6	RUBBER RING 38	1				
028		267299-2	FLAT WASHER 20	1				
029		962211-4	RETAINING RING R-42	1				
030		511A14-5	ARMATURE ASS'Y 220-240V	1				
	C10	240161-6	FAN 86	1				
	D10		INC. 31,32					
031		681025-9	INSULATION WASHER	1				
032		210267-4	BALL BEARING 6200DDW	1				
033		811P45-7	GA7071 SERIAL NO. LABEL	1				
034		456239-7	BAFFLE PLATE	1				
035		621923-5	FIELD 220V	1				
036		266044-2	TAPPING SCREW 5X60	2				
037		266385-6	TAPPING SCREW 4X14	1				
038		183T24-2	BRUSH HOLDER COVER SET	1				
	D10		INC. 43					
039		191T31-1	CARBON BRUSH SET	1				
040		266385-6	TAPPING SCREW 4X14	2				
041		644001-4	BRUSH HOLDER	2				
042		413343-5	MOTOR HOUSING	1				
043		183T24-2	BRUSH HOLDER COVER SET	1				
	D10		INC. 38					
044		266385-6	TAPPING SCREW 4X14	1				
045		620D47-8	CONTROLLER	1				
047		422671-7	VIBRATION PROOF RUBBER	1				
048		232677-5	COMPRESSION SPRING 10	2				
049		312A98-4	SHOE HOLDER	1				
050		422672-5	BRAKE SHOE	1				
051		213118-0	O RING 12	1				
052		313360-4	FAN 45	1				
053		413388-3	SHOE HOLDER CAP	1				
054		140Y86-3	SHOE HOLDER COVER COMPLETE	1				
	C10	263027-3	RUBBER PIN 4	2				
055		266326-2	TAPPING SCREW 4X18	2				
056		422669-4	LINK SEAL	1				

Interchange
O : Yes
X : No
< : the new part can be substituted for the current.
> : the current part can be substituted for the new.
S : Interchangeable as a set.

