



VN	VIETNAM
----	---------

Diagram / Parts List

UH007G

750MM CORDLESS HEDGE TRIMMER

(VN) UH007G / 750MM CORDLESS HEDGE TRIMMER

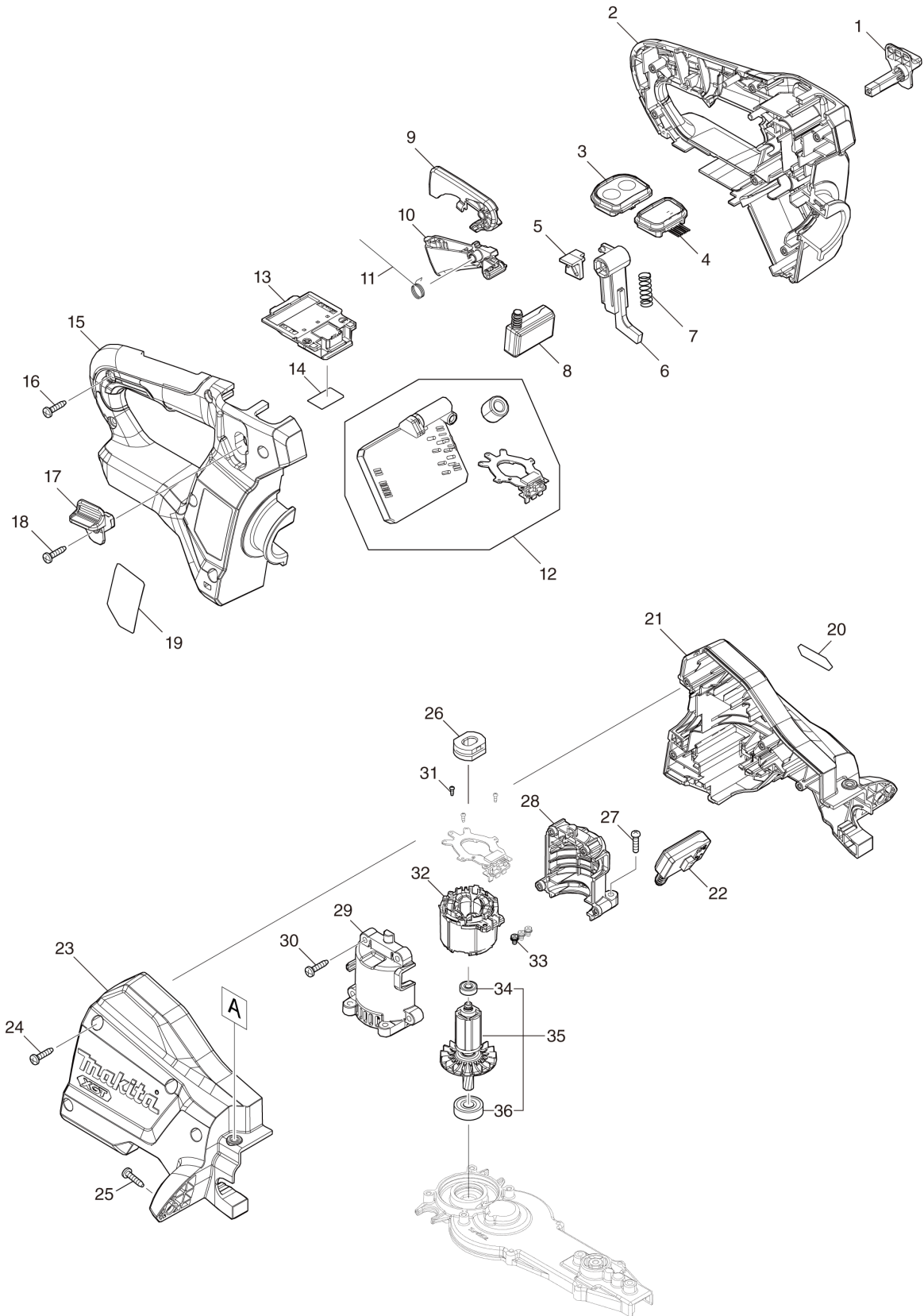

(VN) UH007G / 750MM CORDLESS HEDGE TRIMMER

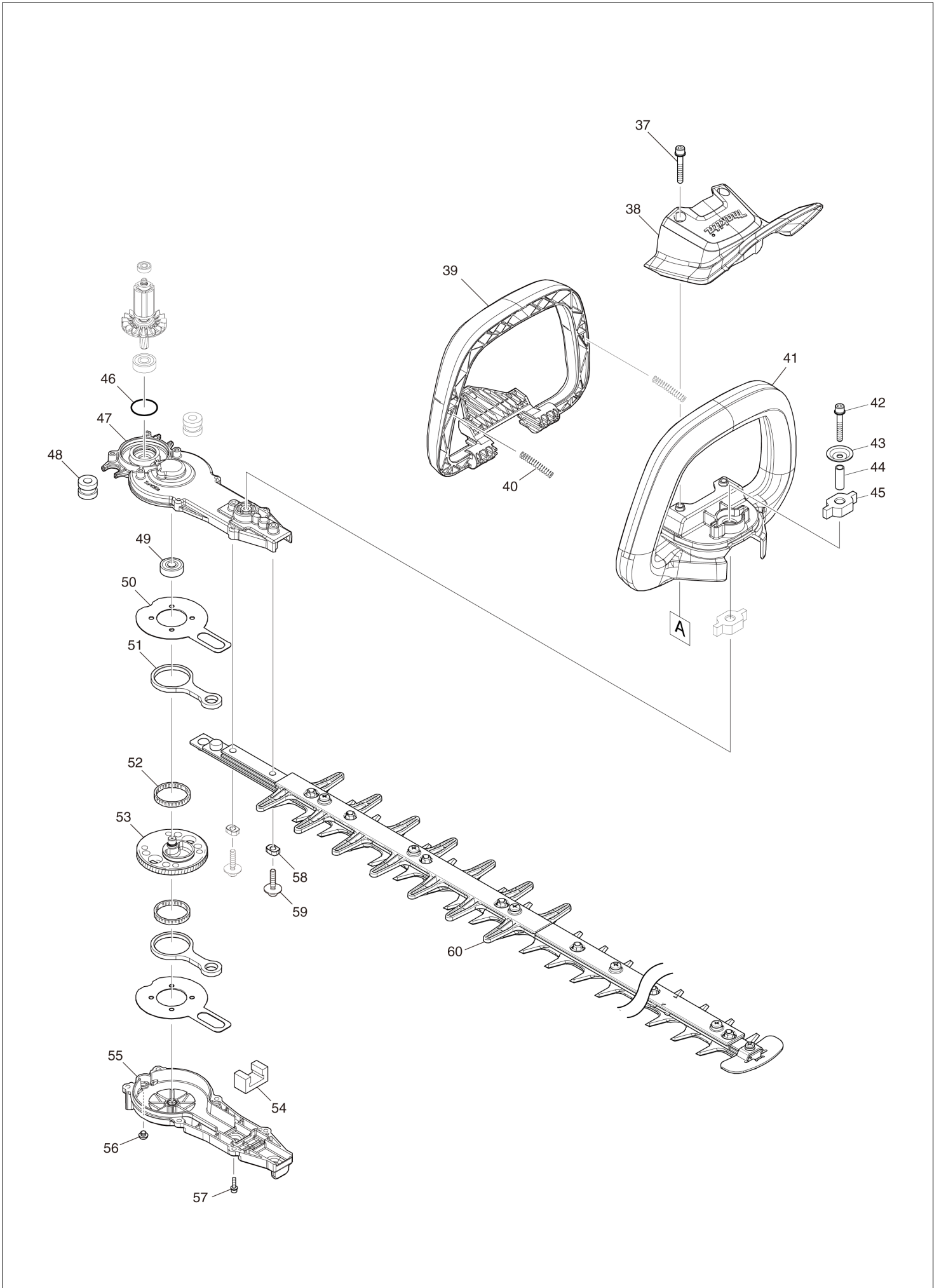

VN	VIETNAM
-----------	----------------

UH007G / 750MM CORDLESS HEDGE TRIMMER

Item	Sub	Parts No.	Parts Description	Qty	I/C	E/C No.	Close No.	Remark
001		458406-0	LOCK LEVER L	1				
002		183T66-6	HANDLE SET	1				
	C10	263005-3	RUBBER PIN 6	2				
	C20	8034N8-3	CAUTION LABEL	1				
	D10		INC. 15					
003		141D66-6	SWITCH CIRCUIT COMPLETE E	1				
	C10	8034K3-2	SWITCH LABEL	1				
004		140W63-3	INDICATION CIRCUIT COMPLETE	1				
005		458570-7	SLIDER	1				
006		458405-2	LOCK ARM	1				
007		234204-4	COMPRESSION SPRING 8	1				
008		651083-9	SWITCH C3XA-1PSPM	1				
009		458403-6	LOCK OFF LEVER	1				
010		413792-6	SWITCH LEVER R	1				
011		232454-5	TORSION SPRING 10	1				
012		620E57-1	CONTROLLER	1				
013		632P64-8	TERMINAL UNIT	1				
014		811J40-1	UH007G SERIAL NO. LABEL	1				
015		183T66-6	HANDLE SET	1				
	C10	263005-3	RUBBER PIN 6	2				
	C20	8034N8-3	CAUTION LABEL	1				
	D10		INC. 2					
016		266326-2	TAPPING SCREW 4X18	6				
017		458407-8	LOCK LEVER R	1				
018		266326-2	TAPPING SCREW 4X18	1				
019		811J37-0	UH007G NAME PLATE	1				
020		8025F3-0	XGT LOGO LABEL	1				
021		183S95-3	HOUSING SET	1				
	C10	424344-8	DAMPER	4				
	D10		INC. 23					
022		651083-9	SWITCH C3XA-1PSPM	1				
023		183S95-3	HOUSING SET	1				
	C10	424344-8	DAMPER	4				
	D10		INC. 21					
024		266326-2	TAPPING SCREW 4X18	4				
025		266326-2	TAPPING SCREW 4X18	2				
026		422261-6	RUBBER SLEEVE	1				
027		911128-8	P.H.SCREW M4X16 WITH WR	4				
028		183S94-5	MOTOR HOUSING SET	1				
	D10		INC. 29					
029		183S94-5	MOTOR HOUSING SET	1				
	D10		INC. 28					
030		266326-2	TAPPING SCREW 4X18	4				
031		266490-9	TAPPING SCREW PT 2X6	3				
032		629A75-2	STATOR	1				
033		652069-6	FLAT HEAD SCREW M3X6	3				
034		211157-4	BALL BEARING 695ZZ	1				
035		519695-3	ROTOR ASSY	1				
	D10		INC. 34,36					
036		210005-4	BALL BEARING 608DDW	1				
037		265182-7	+ PAN HEAD SCREW M5X25	2				
038		458399-1	PROTECTOR	1				
039		458402-8	SWITCH LEVER F	1				
040		233222-9	COMPRESSION SPRING 5	2				
041		413791-8	FRONT GRIP E	1				
042		251476-6	H.S.H.BOLT M5X35 WITH WR	1				
043		253416-0	DISH WASHER 5	1				
044		257678-2	SLEEVE 6	1				
045		422260-8	RUBBER SLEEVE 8	2				
046		213961-7	O RING 22	1				
047		141C50-5	GEAR HOUSING COMPLETE	1				
	C10	263002-9	RUBBER PIN 4	1				
	C20	424344-8	DAMPER	1				
048		422725-0	RUBBER SLEEVE 8	2				
049		211032-4	BALL BEARING 608ZZ	1				

Interchange
O : Yes
X : No
< : the new part can be substituted for the current.
> : the current part can be substituted for the new.
S : Interchangeable as a set.

