



VN	VIETNAM
----	---------

Diagram / Parts List

HR2600

26MM ROTARY HAMMER



(VN) HR2600 / 26MM ROTARY HAMMER

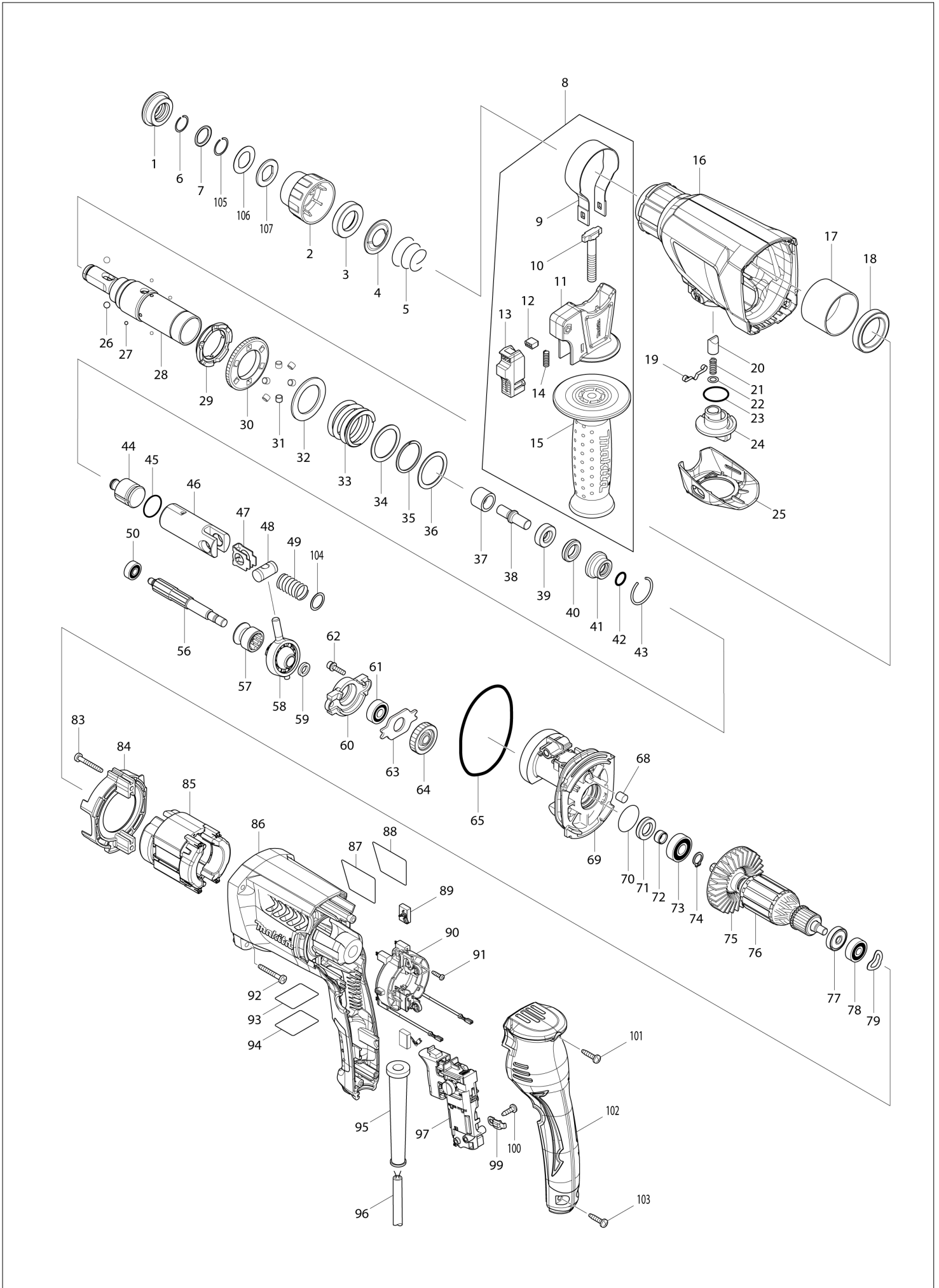

VN	VIETNAM
-----------	----------------

HR2600 / 26MM ROTARY HAMMER

Item	Sub	Parts No.	Parts Description	Qty	I/C	E/C No.	Close No.	Remark
001		286288-8	CAP 35	1				
002		451533-2	CHUCK COVER	1			B4788	
002-1		455393-4	CHUCK COVER	1	S	B4788		
003		325813-1	RING 21	1				
004		346177-0	GUIDE WASHER	1				
005		233916-6	CONICAL COMP. SPRING 21-29	1				
006		233989-9	RING SPRING 14	1				
007		346221-3	WASHER 16	1			B4788	
007-1		346834-0	WASHER 16	1	S	B4788		
008		122878-2	GRIP ASSEMBLY	1				
	D10		INC. 9-15					
009		346181-9	GRIP SPRING 50	1				
010		266349-0	SQUARE BOLT M8X50	1				
011		451539-0	GRIP BASE	1				
012		313179-1	RACK	1			95260	
013		451540-5	LOCK BUTTON	1			95260	
013-1		141765-6	LOCK BUTTON COMPLETE	1	S	95260		
014		233360-7	COMPRESSION SPRING 4	1				
015		154935-8	GRIP 36 COMPLETE	1				
016		140270-0	GEAR HOUSING COMPLETE	1				
	C10	213345-9	OIL SEAL 25	1				
017		331890-3	CUP SLEEVE	1				
018		211294-4	BALL BEARING 6806LLU	1				
019		232152-1	LEAF SPRING	1				
020		325785-0	PUSH CORN	1				
021		234147-0	COMPRESSION SPRING 5	1				
022		253308-3	THIN WASHER 6	1				
023		213381-5	O RING 21	1				
024		451531-6	CHANGE LEVER B	1				
025		451532-4	CHANGE LEVER COVER B	1				
026		216022-2	STEEL BALL 7.0	2				
027		216019-1	STEEL BALL 3	4				
028		140264-5	TOOL HOLDER COMPLETE	1			B4788	
028-1		142973-2	TOOL HOLDER COMPLETE	1	<	B4788		
029		313149-0	DRIVING FLANGE	1			A6980	
029-1		332139-4	DRIVING FLANGE	1	S	A6980		
030		227232-6	SPUR GEAR 51	1			A6980	
030-1		227360-7	SPUR GEAR 51	1	S	A6980		
031		268226-2	PIN 6	6			A6980	
032		267414-8	FLAT WASHER 30	1			A6980	
033		234148-8	COMPRESSION SPRING 31	1				
034		267153-0	FLAT WASHER 30	1				
035		257932-4	SPIRO LOCK WASHER 30	1				
036		267153-0	FLAT WASHER 30	1				
037		325782-6	SLEEVE 9A	1				
038		325789-2	IMPACT BOLT A	1				
039		325794-9	RING 10A	1				
040		424267-0	CUSHION RING 12	1				
041		325798-1	O-RING CASE A	1				
042		213073-6	O RING 9	1				
043		233979-2	RING SPRING 28	1				
044		325784-2	STRIKER	1				
045		213258-4	O RING 17.5	1				
046		310345-1	PISTON CYLINDER	1				
047		346036-8	GUIDE PLATE	1				
048		324215-8	PISTON JOINT	1				
049		234098-7	COMPRESSION SPRING 14	1				
050		211012-0	BALL BEARING 606ZZ	1			A7068	
050-1		210028-2	BALL BEARING 606ZZ	1	O	A7068		
056		227243-1	SPUR GEAR 10	1				
057		331815-7	CLUTCH CAM B	1				
058		219020-5	SWASH BEARING 10	1				
059		267234-0	FLAT WASHER 8	1				
060		310344-3	BEARING BOX	1				
061		211032-4	BALL BEARING 608ZZ	1				

Interchange
O : Yes
X : No
< : the new part can be substituted for the current.
> : the current part can be substituted for the new.
S : Interchangeable as a set.

