



VN	VIETNAM
----	---------

Diagram / Parts List

DUH601

600MM CORDLESS HEDGE TRIMMER



(VN) DUH601 / 600MM CORDLESS HEDGE TRIMMER

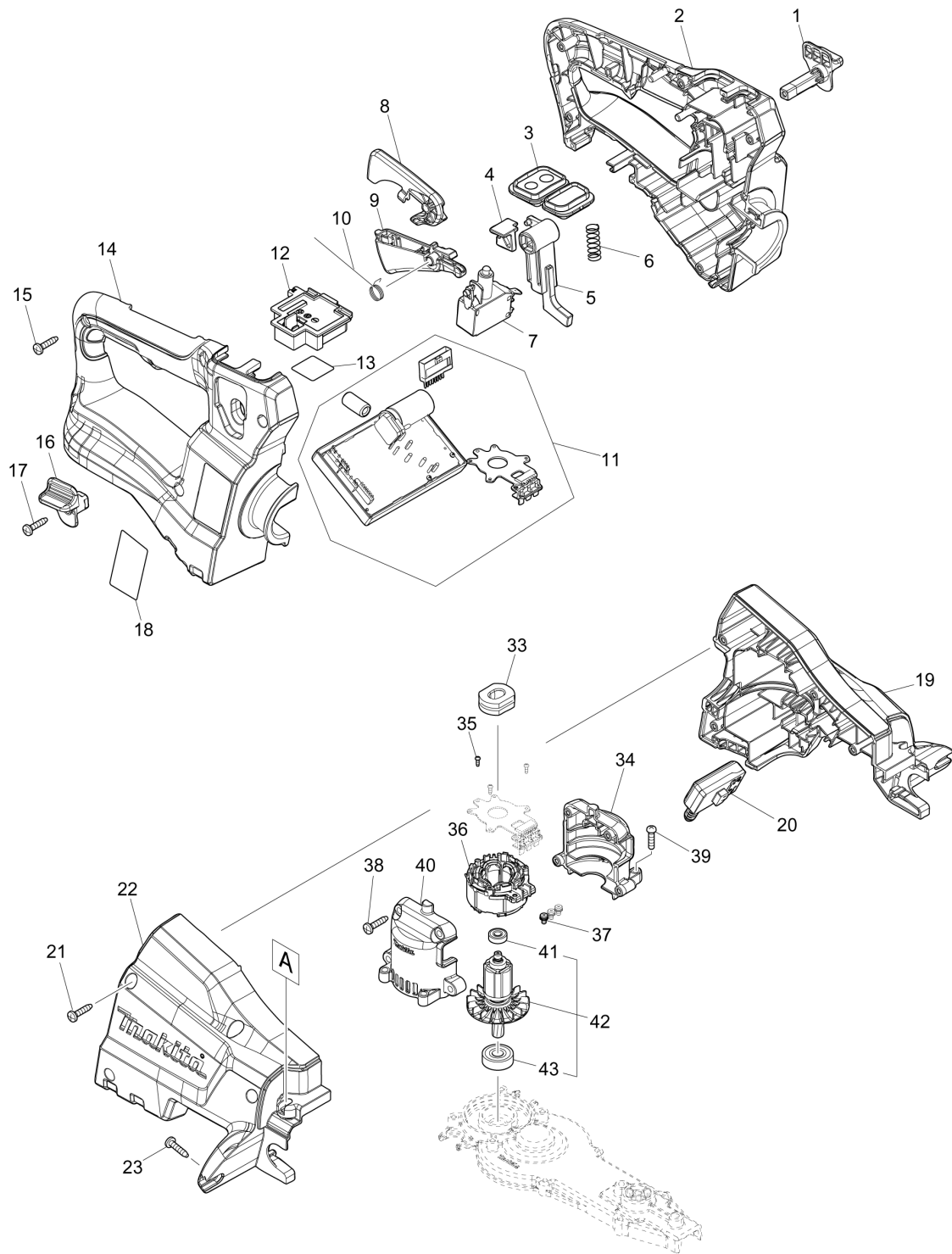

(VN) DUH601 / 600MM CORDLESS HEDGE TRIMMER

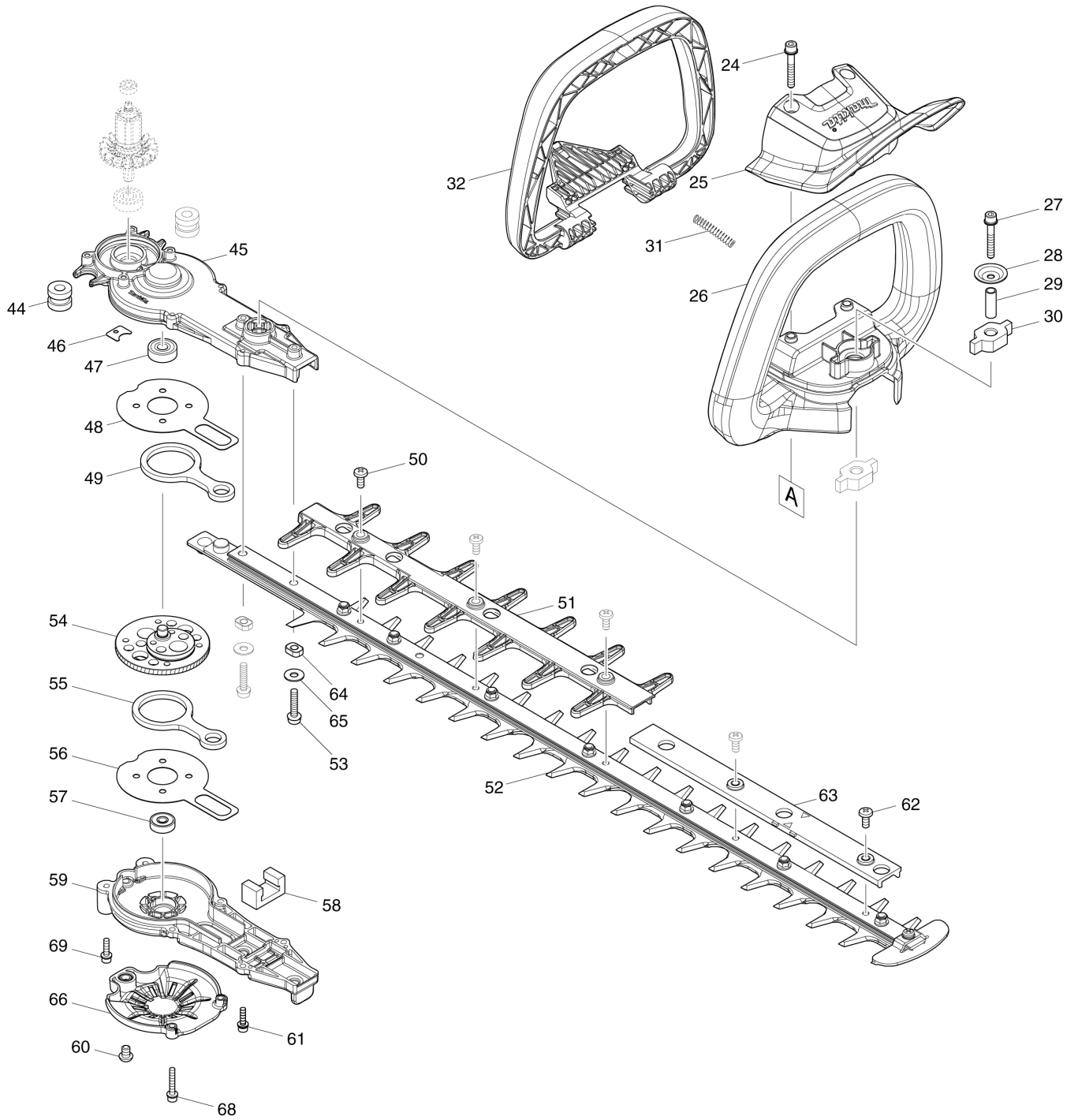

VN	VIETNAM
-----------	----------------

DUH601 / 600MM CORDLESS HEDGE TRIMMER

Item	Sub	Parts No.	Parts Description	Qty	I/C	E/C No.	Close No.	Remark
001		458406-0	LOCK LEVER L	1				
002		183J51-9	HANDLE SET	1				
	C10	263005-3	RUBBER PIN 6	2				
	D10		INC. 14					
003		140A04-7	SUB CONTROLLER COMPLETE	1				
	C10	806G56-1	INDICATION LABEL	1				
	C20	817C42-3	SWITCH LABEL	1				
004		458570-7	SLIDER	1				
005		458405-2	LOCK ARM	1				
006		234204-4	COMPRESSION SPRING 8	1				
007		650781-2	SWITCH C3JW-6B-P	1				
008		458403-6	LOCK OFF LEVER	1				
009		458404-4	SWITCH LEVER R	1				
010		232454-5	TORSION SPRING 10	1				
011		620818-9	CONTROLLER	1			D4249	
011-1		620B18-3	CONTROLLER	1	O	D4249	DA521	
011-2		620E32-7	CONTROLLER	1	<	DA521		
012		644809-6	TERMINAL	1				
013		854K10-3	DUH601 SERIAL NO. LABEL	1				
014		183J51-9	HANDLE SET	1				
	C10	263005-3	RUBBER PIN 6	2				
	D10		INC. 2					
015		266326-2	TAPPING SCREW 4X18	6				
016		458407-8	LOCK LEVER R	1				
017		266326-2	TAPPING SCREW 4X18	1				
018		854K03-0	DUH601 NAME PLATE	1				
019		183K21-4	HOUSING SET	1				
	C10	252143-6	COLLARED HEX.NUT M5-8	2				
	C20	424344-8	DAMPER	4				
	D10		INC. 22					
020		651083-9	SWITCH C3XA-1PSPM	1				
021		266326-2	TAPPING SCREW 4X18	4				
022		183K21-4	HOUSING SET	1				
	C10	252143-6	COLLARED HEX.NUT M5-8	2				
	C20	424344-8	DAMPER	4				
	D10		INC. 19					
023		266326-2	TAPPING SCREW 4X18	2				
024		265182-7	+ PAN HEAD SCREW M5X25	2				
025		458399-1	PROTECTOR	1				
026		458400-2	FRONT GRIP E	1				
027		251476-6	H.S.H.BOLT M5X35 WITH WR	1				
028		253416-0	DISH WASHER 5	1				
029		257678-2	SLEEVE 6	1				
030		422260-8	RUBBER SLEEVE 8	2				
031A		233222-9	COMPRESSION SPRING 5	1			C6737	
031C		233222-9	COMPRESSION SPRING 5	2				
031-1A		233222-9	COMPRESSION SPRING 5	2	O	C6737		
032		458402-8	SWITCH LEVER F	1				
033		422261-6	RUBBER SLEEVE	1				
034A		183J52-7	MOTOR HOUSING SET	1			C6737	
	D10		INC. 40				C6737	
034C		183L66-8	MOTOR HOUSING SET	1				
	D10		INC. 40					
034-1A		183L66-8	MOTOR HOUSING SET	1	<	C6737		
	D10		INC. 40			C6737		
035		266490-9	TAPPING SCREW PT 2X6	3				
036		629352-6	STATOR	1				
037		652069-6	FLAT HEAD SCREW M3X6	3				
038		266326-2	TAPPING SCREW 4X18	4				
039		265178-8	PAN HEAD SCREW M4X16	4			D4810	
039-1		911128-8	P.H.SCREW M4X16 WITH WR	4	O	D4810		
040A		183J52-7	MOTOR HOUSING SET	1			C6737	
	D10		INC. 34				C6737	
040C		183L66-8	MOTOR HOUSING SET	1				
	D10		INC. 34					

A:DUH601Z(N)
C:DUH601PTE(H)

Interchange
O : Yes
X : No
< : the new part can be substituted for the current.
> : the current part can be substituted for the new.
S : Interchangeable as a set.

VN	VIETNAM
-----------	----------------

DUH601 / 600MM CORDLESS HEDGE TRIMMER

Item	Sub	Parts No.	Parts Description	Qty	I/C	E/C No.	Close No.	Remark
040-1A		183L66-8	MOTOR HOUSING SET	1	<	C6737		
	D10		INC. 34			C6737		
041		211157-4	BALL BEARING 695ZZ	1				
042A		519521-6	ROTOR ASSY	1			D2844	
042C		519557-5	ROTOR ASSY	1			D2844	
	D10		INC. 41,43				D2844	
042-1		510450-6	ROTOR ASSY	1	<	D2844	D9869	
	D10		INC. 41,43			D2844	D9869	
042-2		510450-6	ROTOR ASSY	1	O	D9869		
	D10		INC. 41,43			D9869		
043		211032-4	BALL BEARING 608ZZ	1			D2844	
043-1		210005-4	BALL BEARING 608DDW	1	<	D2844		
044		422259-3	RUBBER SLEEVE 8	2				
045		140F22-5	GEAR HOUSING COMPLETE	1			D2844	
	C10	424344-8	DAMPER	1			D2844	
045-1		136278-0	GEAR CASE ASSEMBLY	1	S	D2844		
	C10	424344-8	DAMPER	1		D2844		
	C20	213961-7	O RING 22	1		D2844		
046		458417-5	GASKET	1			D2844	
047		211032-4	BALL BEARING 608ZZ	1				
048		347361-0	FRICTION PLATE	1				
049		347362-8	CONNECTING ROD	1				
050		915211-3	BINDING HEAD SCREW M5X12	3				
051		458408-6	GUARD E	1			D7949	
051-1		412908-0	GUARD E	1	S	D7949		
052		199099-1	SHEAR BLADE ASSEMBLY 600 SET	1			C7471	
	C10	345205-8	BRANCH CATCHER	1			C7471	
	C20	911208-0	PAN HEAD SCREW M5X10	1			C7471	
052-1		199099-1	SHEAR BLADE ASSEMBLY 600 SET	1	<	C7471	D7949	
	C10	345205-8	BRANCH CATCHER	1		C7471	D7949	
	C20	911208-0	PAN HEAD SCREW M5X10	1		C7471	D7949	
052-2		191R53-9	SHEAR BLADE 600 SET	1	<	D7949		
	C10	345205-8	BRANCH CATCHER	1		D7949		
	C20	911208-0	PAN HEAD SCREW M5X10	1		D7949		
053		265182-7	+ PAN HEAD SCREW M5X25	2			D4810	
053-1		265B66-1	+ PAN HEAD SCREW M5X25 WITH WR	2	S	D4810		
054		140B79-2	GEAR COMPLETE	1				
055		347362-8	CONNECTING ROD	1				
056		347361-0	FRICTION PLATE	1				
057		211499-6	BALL BEARING 626ZZ	1				
058		443159-4	SEAL	1				
059		140B62-9	GEAR HOUSING COVER COMPLETE	1				
060A		266559-9	H.S.BUTTON HEAD BOLT M6X4	1				
060C		265338-2	H.S.BOTTON HEAD BOLT M6X8	1				
061A		265490-6	HEX. SOCKET HEAD BOLT M4X16	6			C4150	
061-1A		266437-3	HEX. SOCKET HEAD BOLT M4X16	6	<	C4150		
061-1C		265A29-1	HEX. SOCKET HEAD BOLT M4X16WRM	2				
062		915211-3	BINDING HEAD SCREW M5X12	2				
063A		458628-2	SPACER 600	1				
063C		459115-4	SPACER 600H	1				
064		257439-0	SLEEVE 5	2				
065		253804-1	FLAT WASHER 6	2			D4810	
066C		458907-8	UNDER COVER	1				
068C		265698-2	HEX. SOCKET HEAD BOLT M4X25WRM	2				
069C		265A29-1	HEX. SOCKET HEAD BOLT M4X16WRM	2				
A01A		458414-1	BLADE COVER 600	1				
A01C		459121-9	BLADE COVER 600S	1				
A02		195246-2	SAFETY GOGGLE	1				
A03C		450128-8	BATTERY COVER	1				
A04C		***DC18RD	DC18RD TWO PORT FAST CHARGER	1				
	D10		COMPO-PARTS					
A05C		197280-8	BATTERY BL1850B SET	2			C5219	
A05-1C		197280-8	BATTERY BL1850B SET	2	O	C5219		

A:DUH601Z(N)
C:DUH601PTE(H)

Interchange
O : Yes
X : No
< : the new part can be substituted for the current.
> : the current part can be substituted for the new.
S : Interchangeable as a set.