



ENGLISH (Original Instructions)

INSTRUCTION MANUAL

# Router

3600H

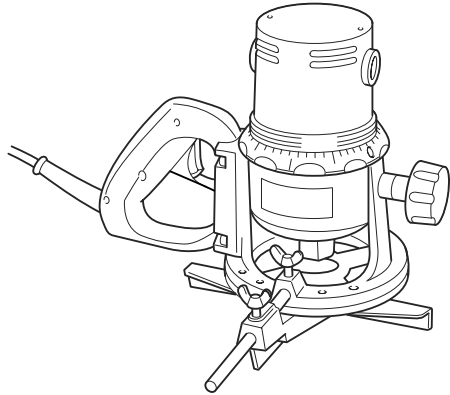

005027

**IMPORTANT:** Read Before Using.

## ENGLISH (Original instructions)

# SPECIFICATIONS

Model	3600H
Collet chuck capacity	12 mm or 1/2"
No load speed (min <sup>-1</sup> )	24,000
Overall height	210 mm
Net weight	4.4 kg
Safety class	Class I

- Due to our continuing program of research and development, the specifications herein are subject to change without notice.
- Specifications may differ from country to country.
- Weight according to EPTA-Procedure 01/2003

END009-1

## Symbols

The following show the symbols used for the equipment. Be sure that you understand their meaning before use.



Read instruction manual.

ENE010-1

## Intended use

The tool is intended for flush trimming and profiling of wood, plastic and similar materials.

ENF001-1

## Power supply

The tool should be connected only to a power supply of the same voltage as indicated on the nameplate, and can only be operated on single-phase AC supply. This tool should be grounded while in use to protect the operator from electric shock. Use only three-wire extension cords which have three-prong grounding-type plugs and three-pole receptacles which accept the tool's plug.

GEA005-3

# General Power Tool Safety

## Warnings

**⚠ WARNING Read all safety warnings and all instructions.** Failure to follow the warnings and instructions may result in electric shock, fire and/or serious injury.

## Save all warnings and instructions for future reference.

The term "power tool" in the warnings refers to your mains-operated (corded) power tool or battery-operated (cordless) power tool.

### Work area safety

1. **Keep work area clean and well lit.** Cluttered or dark areas invite accidents.
2. **Do not operate power tools in explosive atmospheres, such as in the presence of flammable liquids, gases or dust.** Power tools create sparks which may ignite the dust or fumes.

3. **Keep children and bystanders away while operating a power tool.** Distractions can cause you to lose control.

### Electrical safety

4. **Power tool plugs must match the outlet. Never modify the plug in any way. Do not use any adapter plugs with earthed (grounded) power tools.** Unmodified plugs and matching outlets will reduce risk of electric shock.
5. **Avoid body contact with earthed or grounded surfaces such as pipes, radiators, ranges and refrigerators.** There is an increased risk of electric shock if your body is earthed or grounded.
6. **Do not expose power tools to rain or wet conditions.** Water entering a power tool will increase the risk of electric shock.
7. **Do not abuse the cord. Never use the cord for carrying, pulling or unplugging the power tool. Keep cord away from heat, oil, sharp edges or moving parts.** Damaged or entangled cords increase the risk of electric shock.
8. **When operating a power tool outdoors, use an extension cord suitable for outdoor use.** Use of a cord suitable for outdoor use reduces the risk of electric shock.
9. **If operating a power tool in a damp location is unavoidable, use a residual current device (RCD) protected supply.** Use of an RCD reduces the risk of electric shock.
10. **Use of power supply via a RCD with a rated residual current of 30mA or less is always recommended.**

### Personal safety

11. **Stay alert, watch what you are doing and use common sense when operating a power tool. Do not use a power tool while you are tired or under the influence of drugs, alcohol or medication.** A moment of inattention while operating power tools may result in serious personal injury.

12. **Use personal protective equipment. Always wear eye protection.** Protective equipment such as dust mask, non-skid safety shoes, hard hat, or hearing protection used for appropriate conditions will reduce personal injuries.
13. **Prevent unintentional starting. Ensure the switch is in the off-position before connecting to power source and/or battery pack, picking up or carrying the tool.** Carrying power tools with your finger on the switch or energising power tools that have the switch on invites accidents.
14. **Remove any adjusting key or wrench before turning the power tool on.** A wrench or a key left attached to a rotating part of the power tool may result in personal injury.
15. **Do not overreach. Keep proper footing and balance at all times.** This enables better control of the power tool in unexpected situations.
16. **Dress properly. Do not wear loose clothing or jewellery. Keep your hair, clothing, and gloves away from moving parts.** Loose clothes, jewellery or long hair can be caught in moving parts.
17. **If devices are provided for the connection of dust extraction and collection facilities, ensure these are connected and properly used.** Use of dust collection can reduce dust-related hazards.

#### Power tool use and care

18. **Do not force the power tool. Use the correct power tool for your application.** The correct power tool will do the job better and safer at the rate for which it was designed.
19. **Do not use the power tool if the switch does not turn it on and off.** Any power tool that cannot be controlled with the switch is dangerous and must be repaired.
20. **Disconnect the plug from the power source and/or the battery pack from the power tool before making any adjustments, changing accessories, or storing power tools.** Such preventive safety measures reduce the risk of starting the power tool accidentally.
21. **Store idle power tools out of the reach of children and do not allow persons unfamiliar with the power tool or these instructions to operate the power tool.** Power tools are dangerous in the hands of untrained users.
22. **Maintain power tools. Check for misalignment or binding of moving parts, breakage of parts and any other condition that may affect the power tool's operation. If damaged, have the power tool repaired before use.** Many accidents are caused by poorly maintained power tools.
23. **Keep cutting tools sharp and clean.** Properly maintained cutting tools with sharp cutting edges are less likely to bind and are easier to control.
24. **Use the power tool, accessories and tool bits etc. in accordance with these instructions, taking into account the working conditions and the work to be performed.** Use of the power tool for operations different from those intended could result in a hazardous situation.

#### Service

25. **Have your power tool serviced by a qualified repair person using only identical replacement parts.** This will ensure that the safety of the power tool is maintained.
26. **Follow instruction for lubricating and changing accessories.**
27. **Keep handles dry, clean and free from oil and grease.**

GEB105-1

## ROUTER SAFETY WARNINGS

1. **Use clamps or another practical way to secure and support the workpiece to a stable platform.** Holding the work by your hand or against the body leaves it unstable and may lead to loss of control.
2. **Wear hearing protection during extended period of operation.**
3. **Handle the bits very carefully.**
4. **Check the bit carefully for cracks or damage before operation. Replace cracked or damaged bit immediately.**
5. **Avoid cutting nails. Inspect for and remove all nails from the workpiece before operation.**
6. **Hold the tool firmly with both hands.**
7. **Keep hands away from rotating parts.**
8. **Make sure the bit is not contacting the workpiece before the switch is turned on.**
9. **Before using the tool on an actual workpiece, let it run for a while. Watch for vibration or wobbling that could indicate improperly installed bit.**
10. **Be careful of the bit rotating direction and the feed direction.**
11. **Do not leave the tool running. Operate the tool only when hand-held.**
12. **Always switch off and wait for the bit to come to a complete stop before removing the tool from workpiece.**
13. **Do not touch the bit immediately after operation; it may be extremely hot and could burn your skin.**
14. **Do not smear the tool base carelessly with thinner, gasoline, oil or the like. They may cause cracks in the tool base.**

15. Use bits of the correct shank diameter suitable for the speed of the tool.
16. Some material contains chemicals which may be toxic. Take caution to prevent dust inhalation and skin contact. Follow material supplier safety data.
17. Always use the correct dust mask/respirator for the material and application you are working with.

## SAVE THESE INSTRUCTIONS.

### **⚠WARNING:**

DO NOT let comfort or familiarity with product (gained from repeated use) replace strict adherence to safety rules for the subject product. MISUSE or failure to follow the safety rules stated in this instruction manual may cause serious personal injury.

## FUNCTIONAL DESCRIPTION

### **⚠CAUTION:**

- Always be sure that the tool is switched off and unplugged before adjusting or checking function on the tool.

### Adjusting the depth of cut

### **⚠CAUTION:**

- Since excessive cutting may cause overload of the motor or difficulty in controlling the tool, the depth of cut should not be more than 15 mm at a pass when cutting grooves. When you wish to cut grooves more than 15 mm deep, make several passes with progressively deeper bit settings.

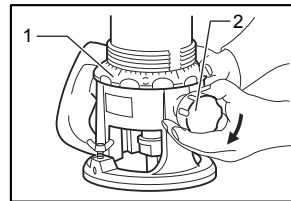

1. Scale ring
2. Knob

005028

Place the tool on a flat surface. Turn the scale ring until it makes contact with the base. Loosen the knob. Turn the scale ring until the bit just touches the flat surface. Tighten the knob. Place the tool upside down and turn the scale ring counterclockwise (when viewing the tool from the top) until the desired depth of cut is obtained. One full turn of the scale ring is equal to 5 mm change in depth setting. Loosen the knob and move the tool base until it makes contact with the scale ring. Then tighten the knob securely.

### Switch action

### **⚠CAUTION:**

- Before plugging in the tool, always check to see that the switch trigger actuates properly and returns to the "OFF" position when released.
- Make sure that the shaft lock is released before the switch is turned on.

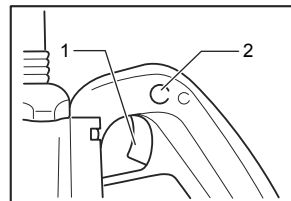

1. Switch trigger
2. Lock button

005029

To start the tool, simply pull the switch trigger. Release the switch trigger to stop.

For continuous operation, pull the switch trigger and then push in the lock button.

To stop the tool from the locked position, pull the switch trigger fully, then release it.

## ASSEMBLY

### ⚠ CAUTION:

- Always be sure that the tool is switched off and unplugged before carrying out any work on the tool.

### Installing or removing the bit

### ⚠ CAUTION:

- Install the bit securely. Always use only the wrench provided with the tool. A loose or overtightened bit can be dangerous.
- Do not tighten the collet nut without inserting a bit or install smaller shank bits without using a collet sleeve. Either can lead to breakage of the collet cone.

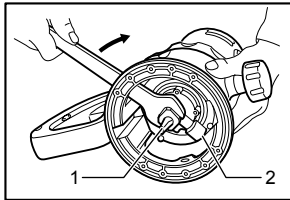

1. Bit
2. Shaft lock

005030

Insert the bit all the way into the collet cone and withdraw it very slightly (approx. 2 mm). Press the shaft lock to keep the shaft stationary and use the wrench to tighten the collet nut securely. When using router bits with smaller shank diameter, first insert the appropriate collet sleeve into the collet cone, then install the bit as described above. To remove the bit, follow the installation procedure in reverse.

## OPERATION

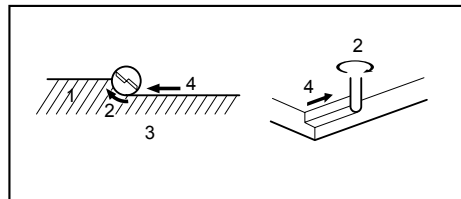

1. Workpiece
2. Bit revolving direction
3. View from the top of the tool
4. Feed direction

001984

Set the tool base on the workpiece to be cut without the bit making any contact. Then turn the tool on and wait until the bit attains full speed. Move the tool forward over the workpiece surface, keeping the tool base flush and advancing smoothly until the cutting is complete.

When doing edge cutting, the workpiece surface should be on the left side of the bit in the feed direction.

### NOTE:

- Moving the tool forward too fast may cause a poor quality of cut, or damage to the bit or motor. Moving the tool forward too slowly may burn and mar the cut. The proper feed rate will depend on the bit size, the kind of workpiece and depth of cut. Before beginning the cut on the actual workpiece, it is advisable to make a sample cut on a piece of scrap lumber. This will show exactly how the cut will look as well as enable you to check dimensions.
- When using the straight guide or the trimmer guide, be sure to install it on the right side in the feed direction. This will help to keep it flush with the side of the workpiece.

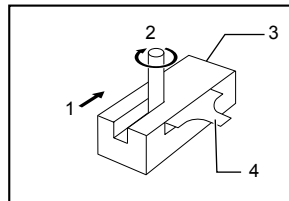

1. Feed direction
2. Bit revolving direction
3. Workpiece
4. Straight guide

001985

### Straight guide

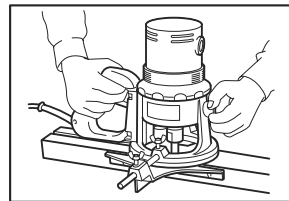

005031

The straight guide is effectively used for straight cuts when chamfering or grooving.

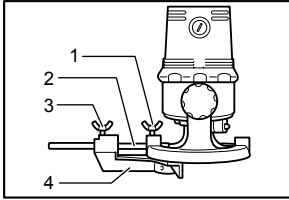

1. Wing bolt (B)
2. Guide bar
3. Wing bolt (A)
4. Straight guide

005032

To install the straight guide, insert the guide bar into the holes in the tool base until the notch in the guide bar reaches just under the wing bolt (B). Then tighten wing bolt (B). Loosen the wing bolt (A) and adjust the distance between the bit and the straight guide. At the desired distance, tighten the wing bolt (A) to secure the straight guide in place.

When cutting, move the tool with the straight guide flush with the side of the workpiece.

### Templet guide

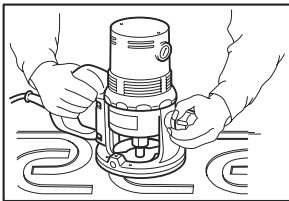

005033

The templet guide provides a sleeve through which the bit passes, allowing use of the tool with templet patterns. To install the templet guide, screw the templet guide on the base plate.

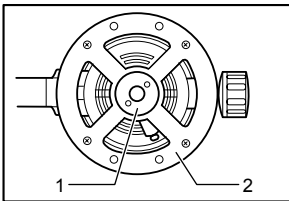

1. Template guide
2. Base plate

005034

Secure the templet to the workpiece. Place the tool on the templet and move the tool with the templet guide sliding along the side of the templet.

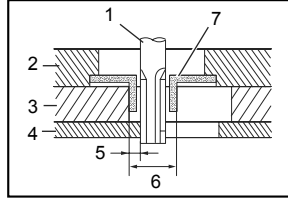

003695

### NOTE:

- The workpiece will be cut a slightly different size from the templet. Allow for the distance (X) between the bit and the outside of the templet guide. The distance (X) can be calculated by using the following equation:

$$\text{Distance (X)} = (\text{outside diameter of the templet guide} - \text{bit diameter}) / 2$$

### Trimmer guide

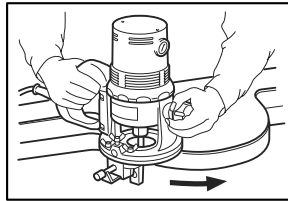

005035

Trimming, curved cuts in veneers for furniture and the like can be done easily with the trimmer guide. The guide roller rides the curve and assures a fine cut.

1. Wing bolt (B)
2. When the bit strikes the trimmer guide, insert a piece of wood into this space.
3. Fine adjusting screw
4. Wing bolt (A)
5. Trimmer guide
6. Guide roller
7. Wing bolt (C)

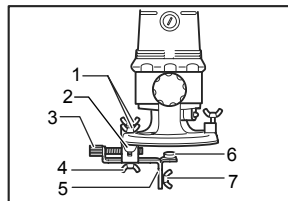

005036

Install the trimmer guide on the tool base with the wing bolts (B). Loosen the wing bolt (A) and adjust the distance between the bit and the trimmer guide by turning the fine adjusting screw (1.5 mm per turn). At the desired distance, tighten the wing bolt (A) to secure the trimmer guide in place. When adjusting the guide roller up or down, loosen the wing bolt (C). After adjusting it, tighten the wing bolt (C) securely.

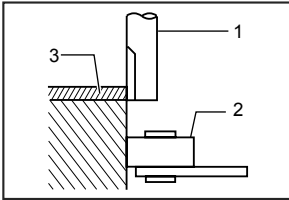

1. Bit
2. Guide roller
3. Workpiece

003701

When cutting, move the tool with the guide roller riding the side of the workpiece.

## MAINTENANCE

### ⚠CAUTION:

- Always be sure that the tool is switched off and unplugged before attempting to perform inspection or maintenance.
- Never use gasoline, benzine, thinner, alcohol or the like. Discoloration, deformation or cracks may result.

### Replacing carbon brushes

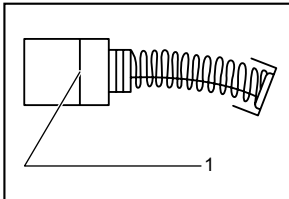

1. Limit mark

001145

Remove and check the carbon brushes regularly. Replace when they wear down to the limit mark. Keep the carbon brushes clean and free to slip in the holders. Both carbon brushes should be replaced at the same time. Use only identical carbon brushes.

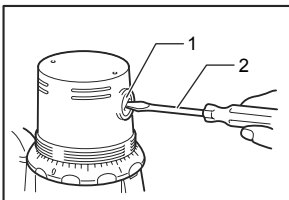

1. Brush holder cap
2. Screwdriver

005037

Use a screwdriver to remove the brush holder caps. Take out the worn carbon brushes, insert the new ones and secure the brush holder caps.

To maintain product SAFETY and RELIABILITY, repairs, any other maintenance or adjustment should be performed by Makita Authorized Service Centers, always using Makita replacement parts.

## OPTIONAL ACCESSORIES

### ⚠CAUTION:

- These accessories or attachments are recommended for use with your Makita tool specified in this manual. The use of any other accessories or attachments might present a risk of injury to persons. Only use accessory or attachment for its stated purpose.

If you need any assistance for more details regarding these accessories, ask your local Makita Service Center.

### Router bits

#### Straight bit

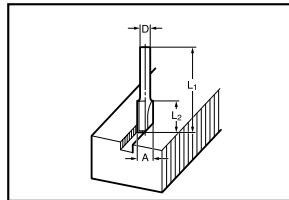

005116

mm			
D	A	L 1	L 2
6	20	50	15
1/4"			
12	12	60	30
1/2"			
12	10	60	25
1/2"			
8	8	60	25
6			
1/4"	8	50	18
6			
1/4"	6	50	18

006452

#### "U" Grooving bit

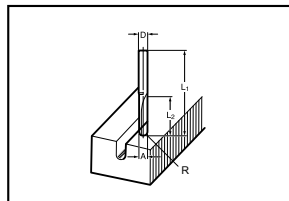

005117

mm				
D	A	L 1	L 2	R
6	6	50	18	3

006453

### "V" Grooving bit

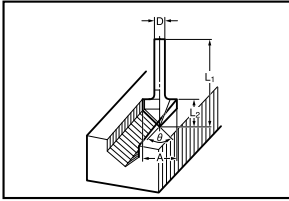

005118

mm				
D	A	L1	L2	$\theta$
1/4"	20	50	15	90°

006454

### Drill point flush trimming bit

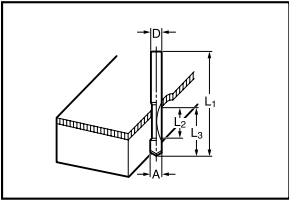

005120

mm				
D	A	L1	L2	L3
12	12	60	20	35
8	8	60	20	35
6	6	60	18	28

006456

### Drill point double flush trimming bit

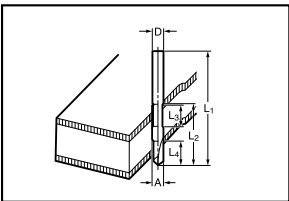

005121

mm					
D	A	L1	L2	L3	L4
6	6	70	40	12	14

006457

### Board-jointing bit

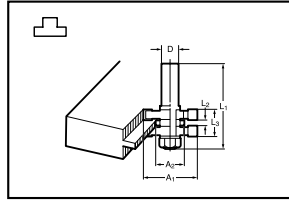

005123

mm					
D	A1	A2	L1	L2	L3
12	38	27	61	4	20

006459

### Corner rounding bit

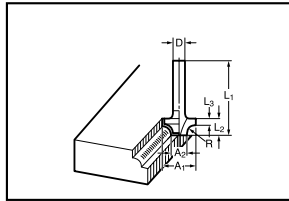

005125

mm						
D	A1	A2	L1	L2	L3	R
6	25	9	48	13	5	8
6	20	8	45	10	4	4

006460

### Chamfering bit

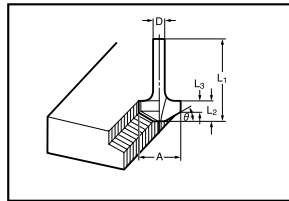

005126

mm					
D	A	L1	L2	L3	$\theta$
6	23	46	11	6	30°
6	20	50	13	5	45°
6	20	49	14	2	60°

006462



### Cove beading bit

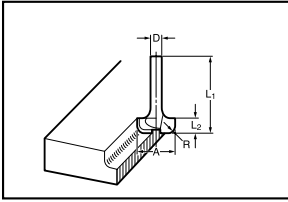

005129

mm				
D	A	L 1	L 2	R
6	20	43	8	4
6	25	48	13	8

006464

### Ball bearing flush trimming bit

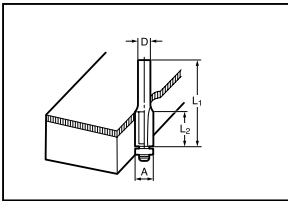

005130

mm			
D	A	L 1	L 2
6	10	50	20
1/4"			

006465

### Ball bearing corner rounding bit

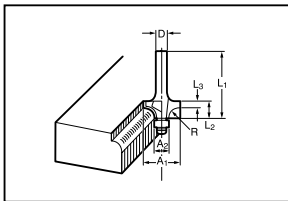

005131

mm						
D	A 1	A 2	L 1	L 2	L 3	R
6	15	8	37	7	3.5	3
6	21	8	40	10	3.5	6
1/4"	21	8	40	10	3.5	6

006466

### Ball bearing chamfering bit

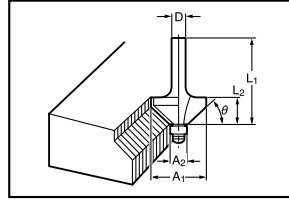

005132

mm					
D	A 1	A 2	L 1	L 2	θ
6	26	8	42	12	45°
1/4"					60°
6	20	8	41	11	60°

006467

### Ball bearing beading bit

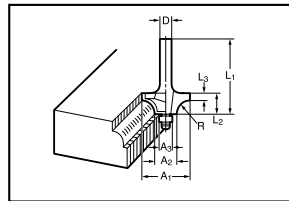

005133

mm							
D	A 1	A 2	A 3	L 1	L 2	L 3	R
6	20	12	8	40	10	5.5	4
6	26	12	8	42	12	4.5	7

006468

### Ball bearing cove beading bit

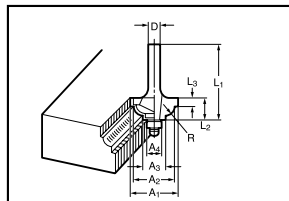

005134

mm								
D	A 1	A 2	A 3	A 4	L 1	L 2	L 3	R
6	20	18	12	8	40	10	5.5	3
6	26	22	12	8	42	12	5	5

006469

## Ball bearing roman ogee bit

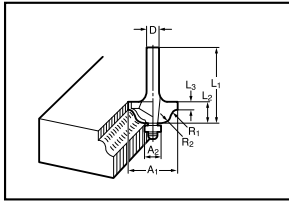

005135

D	A 1	A 2	L 1	L 2	L 3	R 1	R 2
6	20	8	40	10	4.5	2.5	4.5
6	26	8	42	12	4.5	3	6

mm

006470

### NOTE:

- Some items in the list may be included in the tool package as standard accessories. They may differ from country to country.



Makita Corporation